



## CHARGE BAR TABLES

Chargebar Tables create an ideal touchdown place to power up your devices & get some work done. The tables are built on an all-welded steel frame with a high-density HPL top. Chargebars are available in standing height or sitting height & come with Paragon's PD-Flip pop-up power, three outlet, two USB port surge protector.

## FEATURES

### ○ SURFACE/EDGE

1 1/4" HPL with machine applied durable edge band.

### ○ FRAME

16 gauge 1x2" tubular frame welded to 14 gauge flattened oval tubular legs.

### ○ PD-FLIP

Pop-up power, 3 outlet, 2 USB port surge protector.

### ○ HEIGHT OPTIONS

Available in Standing Height of 42" as well as standard Sitting Height of 30".

### ○ COLOR OPTIONS

Five frame paint options with your choice of standard laminate colors for your top surface & a multiple accents to choose from.



PD-Flip



## CONFIGURING A MODEL NUMBER

Choose your family part. Refer to the price list for a list of Chargebar table models. In this example, we used part **AT-AW-CHARGE BAR-722430-910BOR**. The structure of this new part number can be broken up with parenthesis like this:

**[ AT-AW-CHARGE BAR-722430 ] - [ 910 ] [ B ] [ O ] [ R ]**

Family Part

Work  
Surface

Edge  
Color

Frame  
Color

Accent  
Color

**AT-AW-CHARGE BAR-722430**

All-Terrain All-Welded

Chargebar

Table Dimensions

## COLOR & FINISH OPTIONS





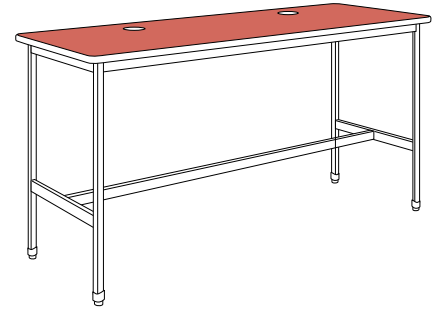









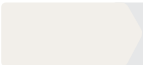

### STEP 1 LAMINATE

Use the number next to the laminate name as the key code for **STEP 1**



[ FAMILY ] - [ WORK SURFACE ]  
[ PART ] - [ SURFACE ]









#### SOLID LAMINATE

 PARAGON RED (910)	 EARTH (185)	 FROST (918)	 CITADEL (303)
 MARS (743)	 STORM (770)	 NEUTRAL WHITE (123)	 NORTH SEA GRAY (535)
 CLEMENTINE (852)	 BLACK (900)	 FASHION GRAY (366)	 PLUM (736)
 ISLAND (229)	 COWBOY BLUE (976)	 FOLKSTONE (902)	 ORANGE GROVE (233)

#### WHITEBOARD LAMINATE

 FROST (189)
---

#### WOOD GRAIN LAMINATE

 HIGH RISE (857)	 RIVER CHERRY (566)	 XANADU (110)	 WENGE STRAND (150)
 KENSINGTON MAPLE (963)	 STUDIO TEAK (103)	 WHEAT STRAND (179)	 BURNT STRAND (400)

#### PATTERN LAMINATE

 WHITE NEBULA (215)	 CARBON EV (890)	 CLASSIC LINEN (155)	 NAVY LEGACY (985)
 CRISP LINEN (122)	 CITADEL WARP (511)	 EARTHEN WARP (119)	 GRAPHITE TWILL (531)
 WHASHI CRYSTAL (440)	 GRAPHITE NEBULA (994)	 DENIM TWILL (281)	 EARTHEN TWILL (161)
 GRAY NEBULA (102)	 WASHI PEWTER (441)	 CLOUD NEBULA (315)	 SARUM TWILL (242)
 PRESSED LINEN (858)	 NEUTRAL WEFT (112)	 TAILORED LINEN (859)	 NEUTRAL TWILL (306)

**NEW COLORS**



**STEP 2**  
**EDGE**

Use the letter next to the color name as the key code for **STEP 2**

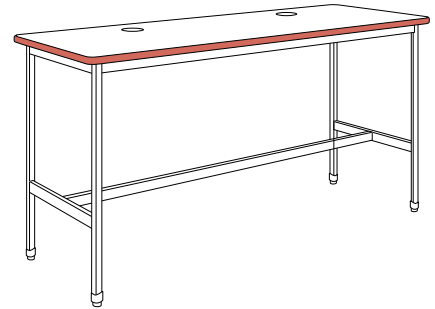

[ FAMILY ] - [ WORK SURFACE ] [ EDGE COLOR ]

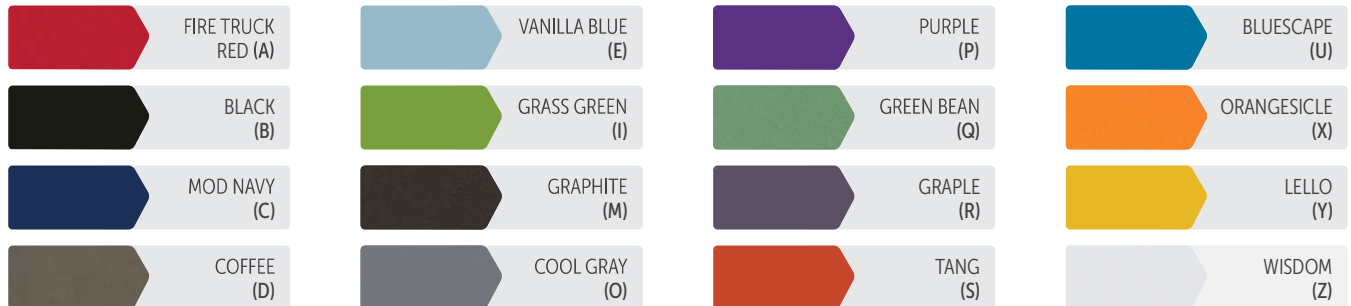

### STEP 3 FRAME

Use the letter next to the color name as the key code for **STEP 3**

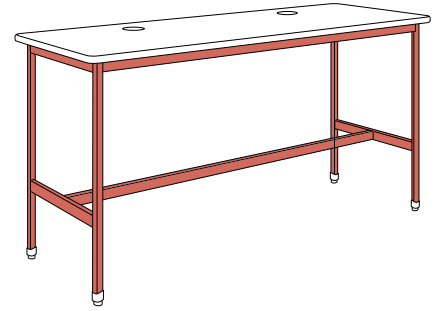

[ FAMILY ] - [ WORK SURFACE ] [ EDGE COLOR ] [ FRAME COLOR ]



BLACK  
(B)



TITANIUM  
(T)



WISDOM  
(Z)



FLANNEL  
(F)



COOL GRAY  
(O)

### STEP 4 PLASTIC ACCENTS

Use the letter next to the color name as the key code for **STEP 4**

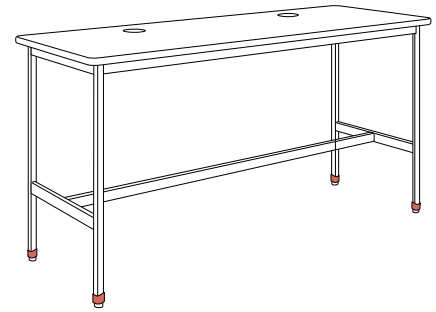

[ FAMILY ] - [ WORK SURFACE ] [ EDGE COLOR ] [ FRAME COLOR ] [ PLASTIC ACCENT ]



FIRE TRUCK  
RED (A)



VANILLA BLUE  
(E)



PURPLE  
(P)



BLUESCAPE  
(U)



BLACK  
(B)



GRASS GREEN  
(I)



GREEN BEAN  
(Q)



ORANGESICLE  
(X)



MOD NAVY  
(C)



GRAPHITE  
(M)



GRAPLE  
(R)



LELLO  
(Y)



COFFEE  
(D)



COOL GRAY  
(O)



TANG  
(S)



WISDOM  
(Z)

**MODEL NUMBERS & PRODUCT SPECS**

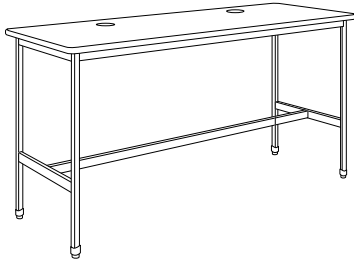

**CHARGEBAR TABLES**

Model #	Width (in)	Depth (in)	Height (in)	Weight (lbs)	Dist. Between Legs (in)	Freight Class (Qty 1)
AT-AW-CHARGEBAR-722430	72	24	30	150	65	150
AT-AW-CHARGEBAR-722442	72	24	42	160	65	150
AT-AW-CHARGEBAR-842430	84	24	30	190	77	150
AT-AW-CHARGEBAR-842442	84	24	42	200	77	150
AT-AW-CHARGEBAR-962430	96	24	30	230	89	150
AT-AW-CHARGEBAR-962442	96	24	42	240	89	150
AT-AW-CHARGEBAR-723030	72	30	30	170	65	150
AT-AW-CHARGEBAR-723042	72	30	42	180	65	150
AT-AW-CHARGEBAR-843030	84	30	30	210	77	150
AT-AW-CHARGEBAR-843042	84	30	42	220	77	150
AT-AW-CHARGEBAR-963030	96	30	30	250	89	150
AT-AW-CHARGEBAR-963042	96	30	42	260	89	150

**POWER PLACEMENT**

