



CYCLE™ SERIES STUDENT DESK

Designed for the Rhythm of Learning

The Cycle™ Series is designed around the natural rhythm of how we learn – much like learning to ride a bike. There's a balance, momentum, and constant moving forward. From early education through high school, Cycle™ supports every stage of the learning journey with furniture that's flexible, mobile, and intuitive.

Inspired by the strength and simplicity of bicycle frames, the collection brings clean lines, smart components, and thoughtful details into the classroom. Each piece is built to adapt – whether students are working independently, collaborating in groups, or engaging with teachers. With Cycle™, classrooms become dynamic environments that move with the learner, supporting growth, exploration, and the evolving cycle of learning.



BALANCE



MOMENTUM



GROWTH



EFFICIENCY

DESIGN & PERFORMANCE HIGHLIGHTS

Research-Driven Design

A unique design informed by research showing that the shape, size, color, and texture of furnishings play an important role in priming students to learn more effectively.

Dynamic & Adaptable

Designed for reliability and easy reconfiguration, supporting flexible classroom layouts and evolving instructional needs.

Fast, Intuitive Assembly

Reduces installation time by at least 50% compared to typical student desks.

Tool-Free Height Adjustment

Simple height adjustment with no hardware or tools required, allowing quick adaptation across grade levels.

Built to Last

Quality materials and construction, manufactured to the same high standards Paragon is known for and backed by our industry-leading limited warranty.

CYCLE™ SERIES STUDENT DESK SIZES

ELEMENTARY HEIGHT STUDENT DESKS

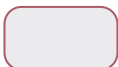

18" x 32"

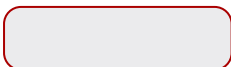

18" x 64"

ADULT HEIGHT STUDENT DESKS

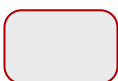

21" x 32"

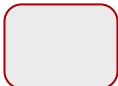

24" x 32"

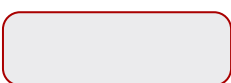

21" x 64"

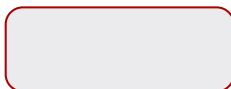

24" x 64"

COUNTER HEIGHT STUDENT DESKS

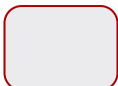

24" x 32"

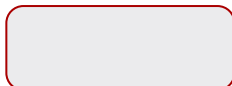

24" x 64"



HOW TO SPECIFY

FRAME

The frame features a sturdy 1½" 16-gauge round steel upper leg and a 1" 16-gauge round steel lower leg, allowing for height adjustability in 1" increments. Each leg is securely supported by a ¼" A36 steel plate for exceptional strength and stability.

SURFACE/EDGE

Constructed with a 1" high-density fiberboard core and a premium high-pressure laminate work surface, the Cycle™ Series Student Desk is built for durability and daily use. Each top features a precision machine-applied edge band for a seamless, long-lasting finish. The underside is sealed with a weather-resistant phenolic resin paper for added protection and stability.

LEG ASSEMBLY

Features the Patent Pending CLICK+SET™ quick-install mounting system with durable glass-filled nylon leg support brackets. Brackets are factory-installed using six countersunk flathead screws, with two 1" machine screws provided for installation.

BEZEL

Patent Pending Glass-filled nylon plastic bezel design requires no additional hardware for installation.

GLIDES

Outfitted with standard adjustable pivoting nylon glides for smooth, stable floor contact and easy repositioning.

BACKPACK HOOK

Includes a durable plastic-molded backpack hook made from glass-filled nylon in the standard Onyx finish.

BACKPACK HOOK



STANDARD FEATURES

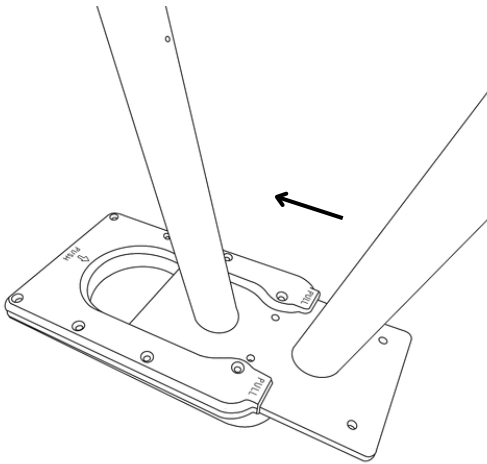

CLICK+SET™

Features the Patent Pending CLICK+SET™ quick-install mounting system with durable glass-filled nylon leg support brackets. Brackets are factory-installed using six countersunk flathead screws, with two 1" machine screws provided for installation.

ENGRAVED HEIGHT GUIDE

Laser-engraved height markings on each leg provide clear visual reference points, making it easy to set and align the desk to the desired height. This simple system removes guesswork during assembly and ensures quick, accurate adjustments every time.

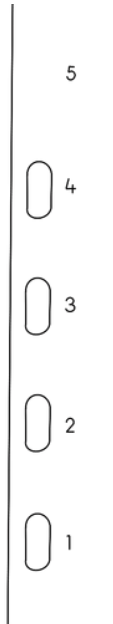

PARAGON
FURNITURE

**CYCLE DESK
HEIGHT GUIDE**

HEIGHT SETTING	X	16"	21"	27"
	SIZE	EH	AH	CH
1	20"	26"	32"	
2	21"	27"	33"	
3	22"	28"	34"	
4	23"	29"	35"	
5	24"	30"	36"	

- LISTED HEIGHTS ARE NOMINAL -

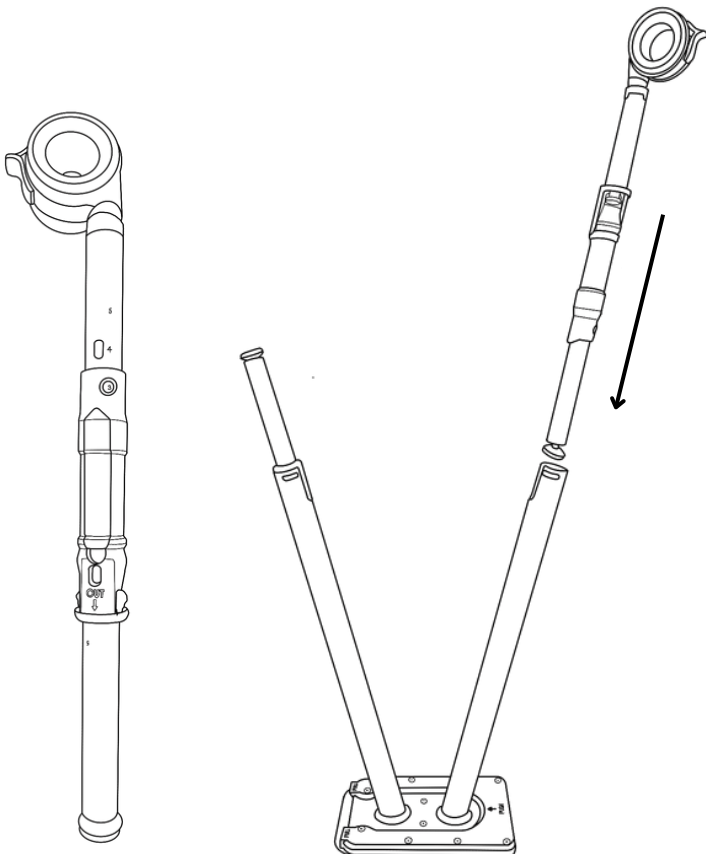

GLIDE TO CASTER CONVERSION

The Patent Pending bezel system allows the lower leg to be easily flipped, revealing two end caps—one designed to accept a glide and the other a caster. This dual-end design allows the desk to quickly convert from a stationary glide base to a mobile caster base without changing components. When not in use, the glide remains attached and rests dormant within the upper leg, keeping it accessible while maintaining a clean, streamlined design. See the video demonstration here:

<https://www.paragoninc.com/cycle-student-desks/>

OPTIONAL ACCESSORIES

CYCLE BOOK BOX 3"

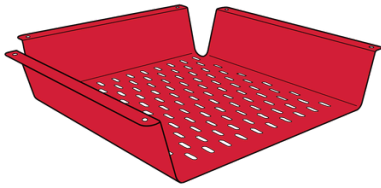

WATER BOTTLE HOLDER

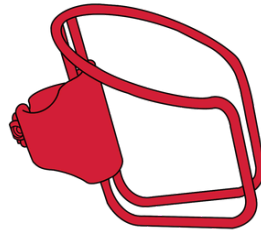

CYCLE HUBLESS CASTER

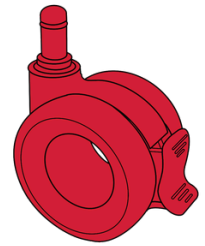

CONFIGURING A MODEL NUMBER

Refer to the Model Numbers & Product Specs section for a list of all family part model numbers in this product line.

Use the chart below as a reference for how to properly specify this product.



[CYC-DAH2132R] - [622] [CO] [CF]

Family Part

Laminate Color

Edge Color

Frame Color

CYC DAH 2132R

Cycle Series™

Desk Adult Height

21 x 32 Rectangle

COLOR & FINISH OPTIONS

STEP 1

WORK SURFACE

[FAMILY] — [WORK]
[PART] — [SURFACE]

Use the code next to the laminate name as the key code for **STEP 1**

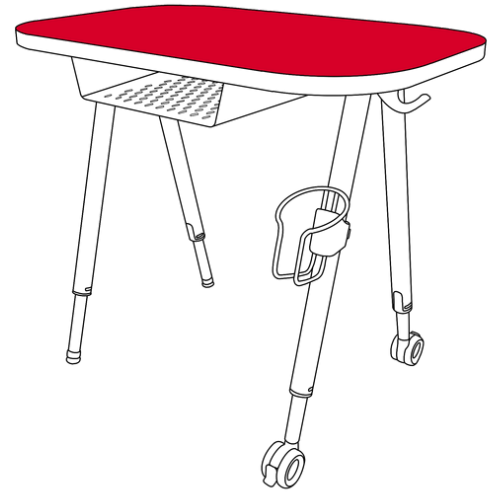

MARKERBOARD LAMINATE

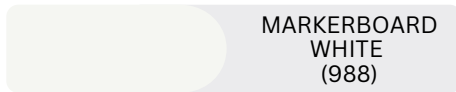

SOLID LAMINATE



WOOD GRAIN LAMINATE

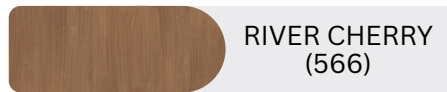
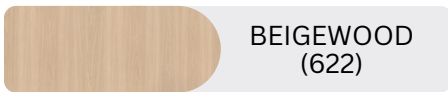

STEP 2

EDGE

[FAMILY] — [WORK] — [EDGE]
[PART] — [SURFACE] — [COLOR]

Use the code next to the color name as the key code for **STEP 2**

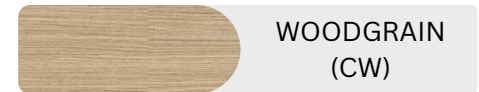
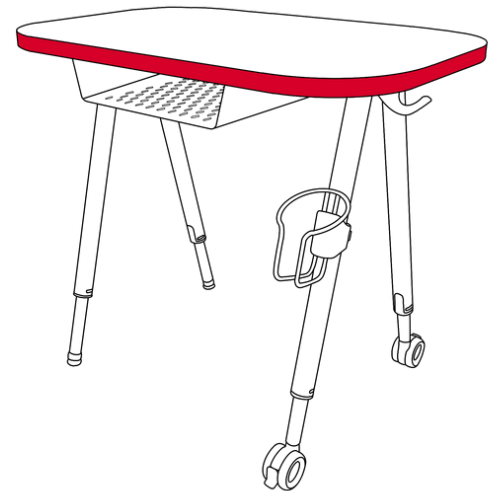

STEP 3

Use the code next to the color name as the key code for **STEP 3**

FRAME

[FAMILY PART] – [WORK SURFACE] – [EDGE COLOR] – [FRAME COLOR]

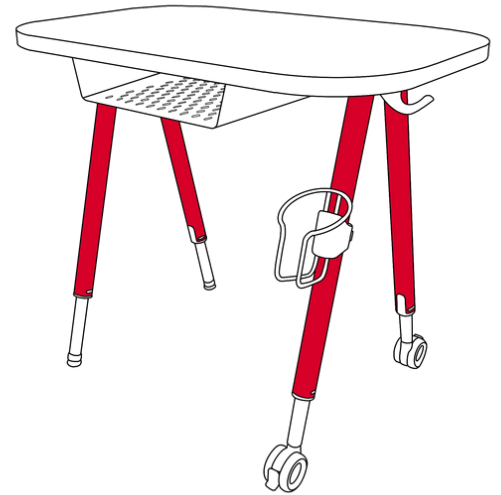

STANDARD

Leg lowers and backpack hooks come standard in Onyx finish.

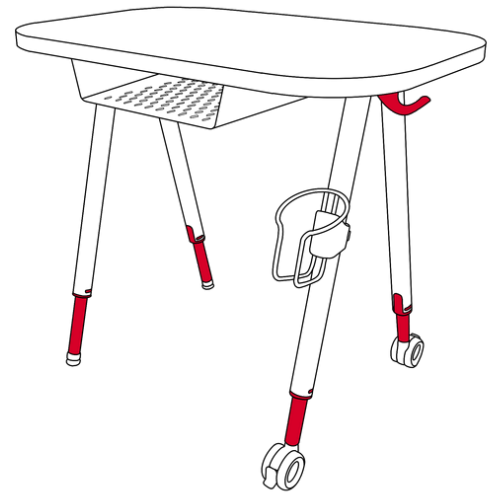

OPTIONAL ACCESSORIES

All accessories, including casters, book box and water bottle holder, come standard in Onyx finish.





MODEL NUMBERS

CYCLE RECTANGLE STUDENT DESK

Model #	Description
CYC-DEH1832R	Cycle Rectangular Adjustable Elementary Height Student Desk
CYC-DEH1864R	Cycle Rectangular Adjustable Elementary Height Student Desk
CYC-DAH2132R	Cycle Rectangular Adjustable Adult Height Student Desk
CYC-DAH2432R	Cycle Rectangular Adjustable Adult Height Student Desk
CYC-DAH2164R	Cycle Rectangular Adjustable Adult Height Student Desk
CYC-DAH2464R	Cycle Rectangular Adjustable Adult Height Student Desk
CYC-DCH2432R	Cycle Rectangular Adjustable Counter Height Student Desk
CYC-DCH2464R	Cycle Rectangular Adjustable Counter Height Student Desk
CYC-HUB2.5X2	Cycle Set of Two Locking Hubless 2.5" Casters (does not increase the height of desk)
CYC-HUB2.5x4	Cycle Set of Four Locking Hubless 2.5" Casters (does not increase the height of desk)
CYC-WBH	Cycle Water Bottle Holder
CYC-BOOKBOX-3	Cycle 3" Perforated Bookbox

PRODUCT SPECS

CYCLE RECTANGLE STUDENT DESK

Model #	Width (in)	Depth (in)	Height (in)	Weight (lbs)	Freight Class (Qty 1)
CYC-DEH1832R	32	18	21-25	40	85
CYC-DEH1864R	64	18	21-25	55	85
CYC-DAH2132R	32	21	26-30	40	85
CYC-DAH2432R	32	24	26-30	45	85
CYC-DAH2164R	64	21	26-30	60	85
CYC-DAH2464R	64	24	26-30	65	85
CYC-DCH2432R	32	24	32-36	45	85
CYC-DCH2464R	64	24	32-36	65	85
CYC-HUB2.5X2			2.5	5	85
CYC-HUB2.5x4			2.5	5	85
CYC-WBH	5	5	5	5	85
CYC-BOOKBOX-3	14	12	3	5	85